

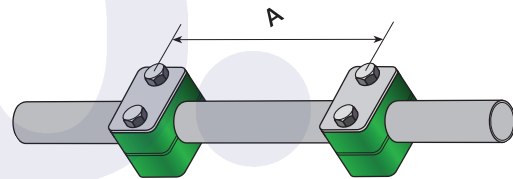

- Iso Componenters **rör-/hydraulikklammer** är tillverkade enligt DIN norm 3015 och används för att fästa alla typer av rör främst inom pneumatik och hydraulik. Vissa kunder använder dem även för kabel och slang.
- Standardmaterialen i klammerkropparna är Polypropylen (PP (grön färg)) eller Aluminium (AL) men finns även i andra material som tex Polyamid6.
- Övre och undre klammerhalvan är identiska.
- Den räfflade insidan har en vibrations- och stötdämpande effekt
- **Rör-/Hydraulikklammer** säljs hos oss både som **kompleta uppsättningar** eller alla **delar/detaljer var för sig**. Klammerkropparna säljs alltid parvis.
- Klammer finns i dimensioner för både Millimeter-, Iso- och Tumrör
- **Rör-/Hydraulikklammer** finns i lätta, tunga och dubbla serien
- Iso Componenters Rör-/Hydraulikklammer är tysktillverkade enligt DIN norm och till 100% kompatibla med Stauff och liknande tillverkare



Rekommenderat monteringsavstånd



	Klammerkropp
<b>Material</b>	PolyPropylen (grön), Aluminium, Polyamid 6 (svart)
<b>Ursprungsland</b>	Tyskland
<b>Dimensioner</b>	6mm - ~400mm
<b>Utförande</b>	Lätta serien (DIN 3015-1) Tunga serien (DIN 3015-2) Dubbla serien (DIN 3015-3)
<b>Fästdetaljer</b>	Stål, Förzinkat stål, Rostfritt (A4, W5)
<b>Kompleta varianter</b>	Se nästa sida

Rör YD Ø mm	A (Avstånd meter)
6,0-12,7	1,0
12,7-22,0	1,2
22,0-32,0	1,5
32,0-38,0	2,0
38,0-57,0	2,7
57,0-75,0	3,0
75,0-76,1	3,5
76,1-88,9	3,7

### ÖVERSIKT DIN 3015-1 KOMPLETTA RÖR- / HYDRAULIKKLAMMER DIN3015-1 (LÄTTA SERIEN)

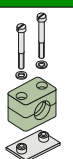
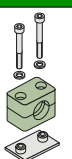
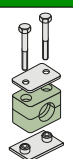
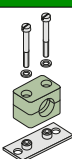
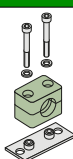
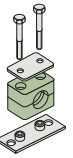
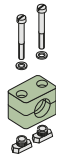
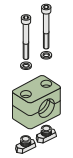
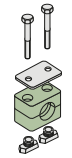
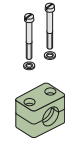
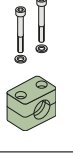
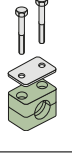
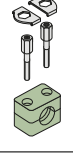
				
<b>RAPR1-</b>	<b>RAPR2-</b>	<b>RAPR3-</b>	<b>RAPR4-</b>	<b>RAPR5-</b>
				
<b>RAPR6-</b>	<b>RAPR9-</b>	<b>RAPR10-</b>	<b>RAPR12-</b>	<b>RAPR13-</b>
			<p>MATERIAL:  <b>RAPR</b> = Polypropylen (PP)  <b>RAPG</b> = PP slät insida</p> <p><b>RANR</b> = Poylamid 6 (PA)  <b>RANG</b> = PA slät insida</p> <p><b>RAVG</b> = Gummi  <b>RAAR</b> = Aluminium</p> <p>Dimension: 6mm - 57mm                      För mer detaljerad beskrivning, se vår produktkatalog</p>	
<b>RAPR14-</b>	<b>RAPR16-</b>	<b>RAPR18-</b>		

*Beställningsexempel*  
**RAPR3 - 112**

- Variant
- Material
- Komplet modell
- Storleksgrupp
- Rördimension

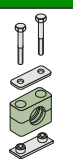
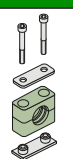
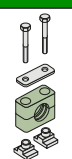
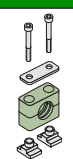
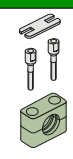
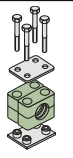
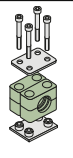

### ÖVERSIKT DIN 3015-2 KOMPLETTA RÖR- / HYDRAULIKKLAMMER DIN3015-2 (TUNGA SERIEN)

				
<b>RCPR1-</b>	<b>RCPR2-</b>	<b>RCPR3-</b>	<b>RCPR4-</b>	<b>RCPR5-</b>
		<p>MATERIAL:  <b>RCPR</b> = Polypropylen (PP)  <b>RCPG</b> = PP slät insida</p> <p><b>RCNR</b> = Poylamid 6 (PA)  <b>RCNG</b> = PA slät insida</p> <p><b>RCVG</b> = Gummi  <b>RCAR</b> = Aluminium</p> <p>Dimension: 6mm - 220mm                      För mer detaljerad beskrivning, se vår produktkatalog</p>		
<b>RCPR1-</b>	<b>RCPR2-</b>			

*Beställningsexempel*  
**RCPR3 - 112**

- Variant
- Material
- Komplet modell
- Storleksgrupp
- Rördimension





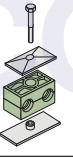
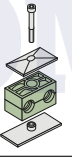
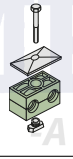
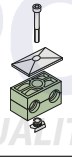
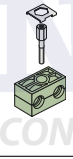





































### ÖVERSIKT DIN 3015-3 KOMPLETTA RÖR- / HYDRAULIKKLAMMER DIN3015-3 (DUBBLA SERIEN)

				
<b>RBPR1-</b>	<b>RBPR3-</b>	<b>RBPR4-</b>	<b>RBPR5-</b>	<b>RBPR8-</b>
				<p>MATERIAL:  <b>RBPR</b> = Polypropylen (PP)  <b>RBPG</b> = PP slät insida</p> <p><b>RBNR</b> = Poylamid 6 (PA)  <b>RBNG</b> = PA slät insida</p> <p><b>RBVG</b> = Gummi</p> <p>Dimension: 6mm - 42mm                      För mer detaljerad beskrivning, se vår produktkatalog</p>

*Beställningsexempel*  
**RBPR3 - 112**

- Variant
- Material
- Komplet modell
- Storleksgrupp
- Rördimension



<b>Enkla serien</b>	 RAPR Klamma (sid.2)	 APK Svetsplatta (sid.2)	 APL Förlängd svetsplatta (sid.3)	 APRL Radsvetsplatta (sid.3)	 TS-A/B Bärskena (sid.4)	 TM-A/B Bärskensmutter (sid.4)	 DP-A Täckplatta (sid.5)
	 SL-A Spänskruv (sid.5)	 SS-A Sexkantsbult (sid.5)	 IS-A Insexskruv (sid.5)	 AS-A Påbyggnads-skruv (sid.6)	 SBR-A Säkringsplatta (sid.6)	 US-A/B Läsbricka (sid.6)	
<b>Dubbla serien</b>	 RBPR Klamma (sid.7)	 AP-B Svetsplatta (sid.7)	 APR-B Radsvetsplatta (sid.8)	 TS-A/B Bärskena (sid.8)	 TM-A/B Bärskensmutter (sid.8)	 SS-B Sexkantsbult (sid.9)	 DP-B Täckplatta (sid.9)
	 AS-B Påbyggnads-skruv (sid.10)	 SB-B Säkringsplatta (sid.10)	 US-A/B Läsbricka (sid.10)	 IS-B Insexskruv (sid.10)			
<b>Tunga serien</b>	 RCPR Klamma (sid.11-12)	 AP-C Svetsplatta (sid.13)	 APL-C Förlängd svetsplatta (sid.13)	 TS-C Bärskena (sid.13)	 TM-C Bärskensmutter (sid.14)	 SS-C Sexkantsbult (sid.14)	 DP-C Täckplatta (sid.14)
	 SP-C Säkringsplatta (sid.15)	 US-C Läsbricka (sid.15)	 IS-C Insexskruv (sid.15)				
	 Komplett Lätta serien (sid.16-19)	 Komplett Dubbla serien (sid.20)	 Komplett Tunga serien (sid.21-22)	 Monterings anvisning (sid.23)	 Byggekamrer (sid.24-25)	 Rörstöd (sid.26-27)	